

# Installation d'un PAILLON SYNTHÉTIQUE

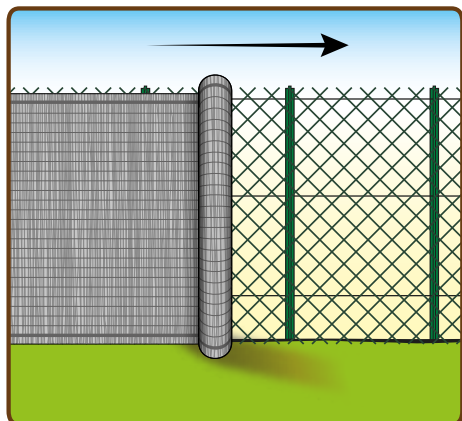

1 Pose sur grillage.

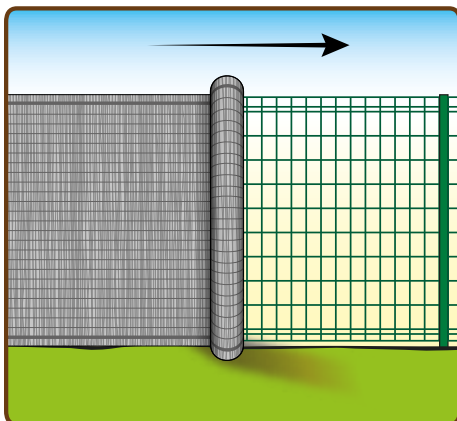

2 Pose sur panneaux rigides.

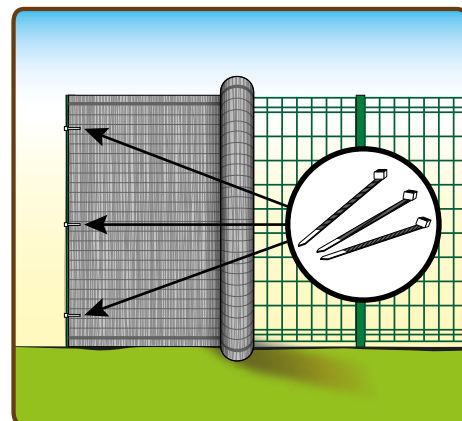

3 Départ avec les liens permanents.

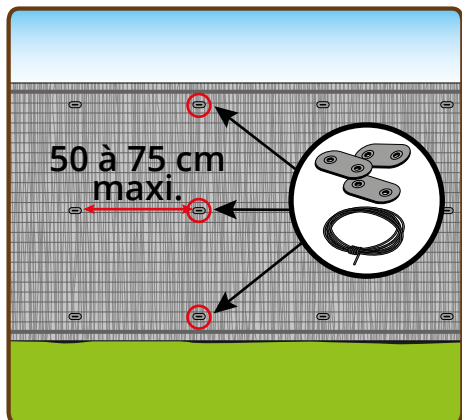

4 Fixation avec les attaches spécial canisses.

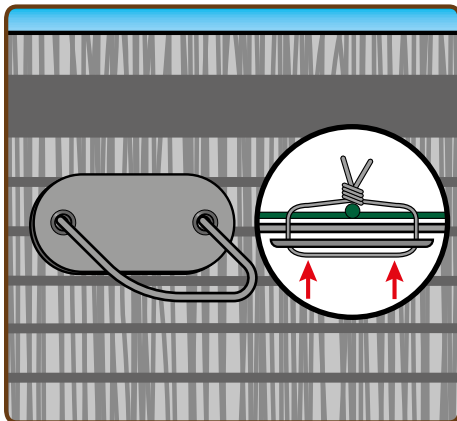

5

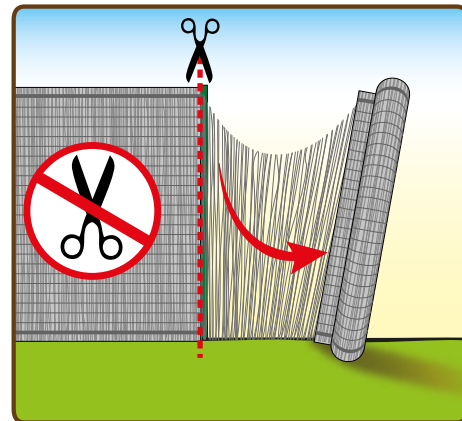

6 **ATTENTION :**  
Ne pas couper la canisse !

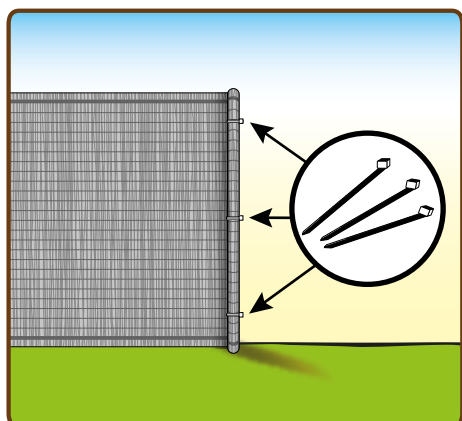

7 Enroulez l'excédent en fin de clôture et fixez-le avec les liens permanents.

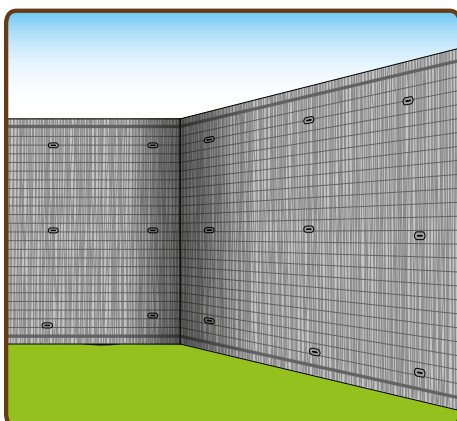

8